



INSTALLATION DATA

5300, 5320, 5330 & 5380 SERIES COMMERCIAL & DOMESTIC ELECTRIC THERMOSTATS

The Robertshaw® 5300, 5320, 5330, and 5380 Series commercial and domestic electric thermostats are SPST snap-acting switches. All but the 5380 Series are available as a Uni-Kit®. Kit controls have a 2" break off stem which is grooved at all standard lengths. The mounting brackets are slotted for various mounting dimensions (1-1/8" to 1-3/4") and are easily adaptable. Screw-to-spade adaptors are included together with a 4-way Slip-Fit® dial. All but the 5380 Series are available in standard or pilot duty models.

The 5300 Series is available in direct (open or temperature rise) or reverse (close on temperature rise) acting modes. Some models include an auxiliary switch.

The 5320 and 5330 Series are direct acting and designed for use on gas fired equipment using an electric thermostat. The 5320's have clockwise to off dial rotation where as the 5330 have counter clockwise to off.

The 5380 Series is a direct or reverse acting control enclosed in a weather proof protective heavy cast aluminum case. The control's sensing bulb and capillary are plated for use in a corrosive atmosphere or liquid.

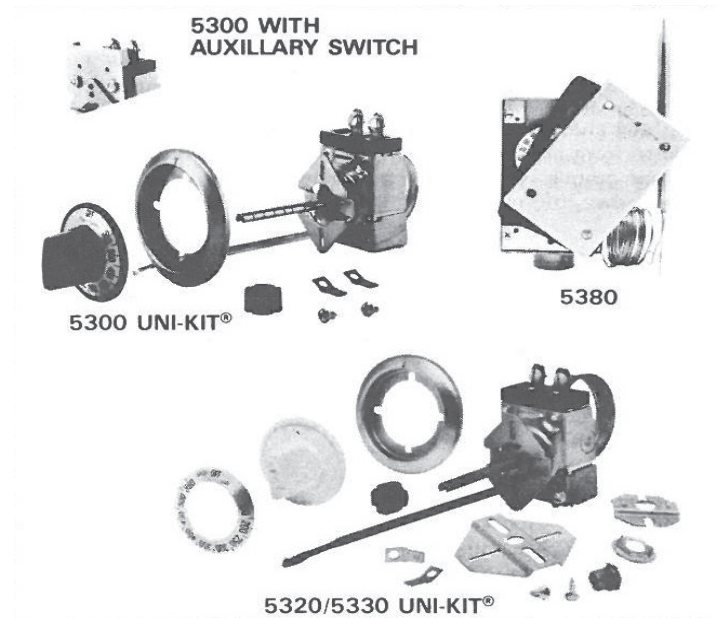

CAUTION

THIS DEVICE SHOULD BE INSTALLED BY A QUALIFIED SERVICE TECHNICIAN WITH DUE REGARD FOR SAFETY AS IMPROPER INSTALLATION COULD RESULT IN A HAZARDOUS CONDITION.

ELECTRICAL RATINGS

FACTORY MODEL TYPE	ELECTRICAL RATING (CYCLING CONTACTS ONLY)
KRAL, KX, KXA, KXH, KXL, KXP, KXR, KXRH, KXRL, KXRAL	50 VA Pilot-Duty at 120/277V AC
EA17, EA17A, EA17AP, EA17F, EA17H, EA17L, EA17LP, EA17P, EA18, KXN, KXNP, KXRN	125 VA Pilot- Duty at 120/277V AC
EA3, EA3A, EA3AP, EA3B, EA3L, EA3P, EA4, EA7, EA7A, EA7P, K, KA, KAP, KB, KH, KL, KP, KR, KRH, KRL	Resistive Load: 25 Amp at 250V AC Inductive Load: 13 Amp Full Load 50 Amp Lock Rotor at 120/ 250V AC 125 VA Pilot-Duty at 120/277V AC
EA9, KM, KN, KNP	Resistive Load: 27 Amp at 208V AC 25 Amp at 240V AC 22.5 Amp at 277V AC 20 Amp at 480V AC 125 VA Pilot-Duty at 120/277V AC
EA5, EA5A, EA5AP, EA5B, EA5E, EA5F, EA5H, EA5J, EA5JL, EA5L, EA19, S, SA, SB, SH, SJ, SJL, SN, SNP, SL, SP, SR	Resistive Load: 30 Amp at 277V AC 20 Amp at 480V AC Inductive Load: 18 Amp Full Load 72 Amp Lock Rotor at 250V AC 125 VA Pilot-Duty at 120/277V AC

5320, 5330 & 5380 SERIES

MODEL TYPE	ELECTRICAL RATING (CYCLING CONTACTS ONLY)
Standard duty models	30 amp. res. 277V AC 18 FL. 72 LR. at 250V AC 125 VA P.D. at 120/277V AC
Pilot duty models	50 VA P.D. at 120/277V AC

5300 AUXILIARY SWITCH

Switch type is indicated by a letter designation in the Factory Model Number. Examples: EA3A-502-12 has a type "A" switch, SJ-170-36 has a type "J" switch.

SWITCH TYPE	SWITCH DESCRIPTION
A	SPST auxiliary switch rated for 25 Amp at 240V AC. Switch is energized continuously in the dial "on" position. Does not cycle with the main contacts.
B	SPDT auxiliary switch rated for 25 Amp at 250V AC. Bake contacts are energized continuously in the dial "on" position. Broil contact is made when dial is turned to "high" stop. Auxiliary switch contacts do not cycle with the main contacts.
E	SPDT auxiliary switch rated for 25 Amp at 250V AC. Has full dial variable broil function when turned to the "high" stop position. Bake contacts are energized continuously in the dial "on" position. Broil contacts are made when dial is turned to "high" stop. Auxiliary switch contacts do not cycle with the main contacts.
F	SPDT auxiliary switch same as "E" designation, except switch is rated for 15 Amp at 240V AC.
J	SPST auxiliary switch rated for 30 Amp at 240V AC. Switch is energized continuously in the dial "on" position. Does not cycle with the main contacts.

INSTALLATION INSTRUCTIONS

NOTE: Do not mount the thermostat where it will be subject to grease, dust, lint or corrosive vapors (except 5380 Series). Do not mount the thermostat where it will be subjected to vibration as vibration will cause thermostat to act erratically. Maximum ambient temperature is 150°F.

Turn off power to equipment before servicing.

5300, 5320, 5330 SERIES

For direct replacements (non-Uni-Kits) follow steps 1, 4, 5, 6 and 7.

1. Remove the old control taking note of capillary routing and sensing bulb entry into the oven equipment, and lead wire terminal connections.
2. Take old control and measure length of dial shaft. Find the groove on dial shaft of new control, which is closest to measurement taken from old control. Using two pliers place one on each side of the groove selected (see figure below). Hold pliers tightly and bend away from the stem flat.

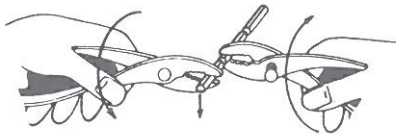

STEM FLAT DOWN

3. If a pilot light is required order pilot light kit A4590-013 separately. (220V applications only) Determine where pilot light is to be on final installation. Remove screws No. 1 or 2 (see figure right) depending on location desired. Install the long screw provided in pilot light kit in place of one just removed. Place pilot light into position, tighten but do not over tighten the nut provided. Connect the two lead wires to the terminals on control.
4. Route capillary and sensing bulb of new control back into the oven equipment as noted in step 1.
5. Connect the terminal wires using the screw-to-spade terminal adaptors if required.
6. Mount the control using the two self-tapping screws provided, which allow for horizontal and palnut mounting. (See figure B) If control has a pilot light use old bezel, otherwise use new bezel, if so desired.
7. If using the 4-way Slip-Fit dial, assemble it per the enclosed separate instruction sheet. Place new or customer's old dial onto shaft. If it does not fit snugly, place a screwdriver into shaft (see figure B) and twist slightly to spread shaft.

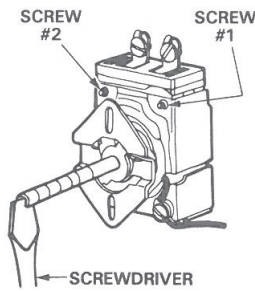

5380 SERIES

1. Remove the old control and case taking note of capillary routing and sensing bulb entry into equipment, retain mounting screws.
2. Assemble mounting bracket to rear of control using self-tapping screws. (See figure C)

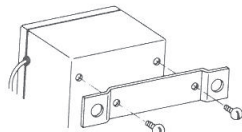

FIGURE C

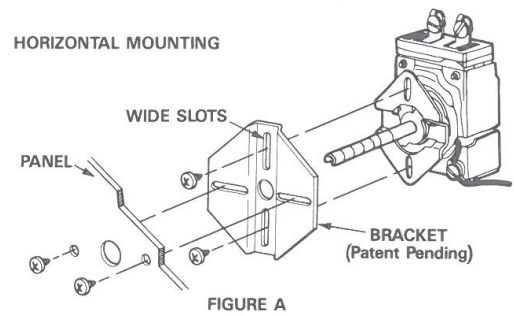
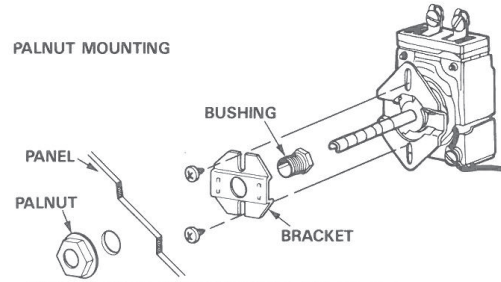

FIGURE A



NOTE: BRACKET MAY BE ROTATED 90° BY FIRST ATTACHING HORIZONTAL MOUNTING BRACKET.

FIGURE B

3. Remove front cover and connect conduit to case pulling lead wires through opening.
4. Connect lead wires and mount the case.
5. Set the dial at desired temperature and replace the front cover including gasket.

CALIBRATION INSTRUCTIONS

These controls are precision instruments that have been carefully calibrated at the factory and seldom need to be recalibrated.

However, if calibration is necessary, the following procedures are recommended:

1. Place the sensing element of a reliable digital thermometer in the center of the area being controlled.
2. Turn the dial to the midpoint of its adjustable range and allow the equipment to come to a stable temperature. Allow the unit to cycle two or more times. Then compare the temperature setting on the dial with the reading of the test instrument.
3. Holding the dial stem stationary, turn the small adjusting screw (see figure to the right) clockwise if the temperature in the device is above the dial setting and counterclockwise if the temperature is below the dial setting. One quarter turn of the screw will change the setting approximately the degrees shown in the chart below.
4. Recheck calibration and repeat steps if closer calibration is required.

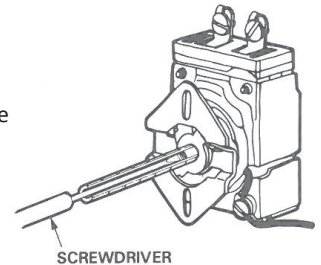

	TEMPERATURE RANGE ON CONTROL DIAL (°F)					
	60-95°	60-250°	100-220°	130-180°	140-550°	200-400°
APPROXIMATE TEMPERATURE CHANGE PER 1/4 TURN (°F)	6°	17°	12°	14°	35°	18°



Customer Service Telephone 1.800.304.6563
Customer Service Facsimile 1.800.426.0804
HVACCustomerService@robertshaw.com

For Technical Service
Telephone 1.800.445.8299
Facsimile 1.630.260.7294
TechnicalService@robertshaw.com

Robertshaw®, Ranco®, Paragon® and Uni-Line® are trademarks of Robertshaw its subsidiaries and/or affiliated companies. All other brands mentioned may be the trademarks of their respective owners.

www.uni-line.com
www.robertshaw.com
©2014 Robertshaw
08/14 -1-189 RevD